

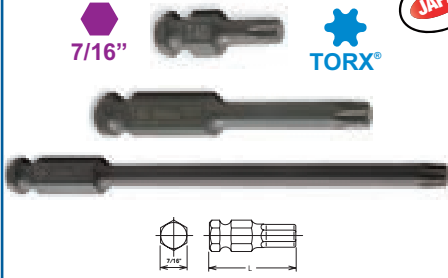

7/16"

TORX®

JAPAN



## INSERTO CON MASCHIO TORX®

Koken articolo		L mm	
183T-35-T25	TX 25	35	1
183T-35-T30	TX 30	35	1
183T-35-T40	TX 40	35	1
183T-35-T45	TX 45	35	1
183T-35-T50	TX 50	35	1
183T-35-T55	TX 55	35	1
183T-35-T60	TX 60	35	1
183T-75-T30	TX 30	75	1
183T-75-T40	TX 40	75	1
183T-75-T45	TX 45	75	1
183T-75-T50	TX 50	75	1
183T-75-T55	TX 55	75	1
183T-75-T60	TX 60	75	1
183T-150-T30	TX 30	150	1
183T-150-T40	TX 40	150	1
183T-150-T45	TX 45	150	1
183T-150-T50	TX 50	150	1
183T-150-T55	TX 55	150	1



7/16"

TORXplus®

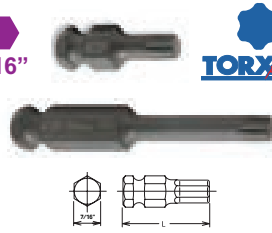
JAPAN



## INSERTO CON MASCHIO TORX PLUS®

Koken articolo		L mm	
183T-35-30IP	30IP	35	1
183T-35-40IP	40IP	35	1
183T-35-45IP	45IP	35	1
183T-35-50IP	50IP	35	1
183T-35-55IP	55IP	35	1
183T-35-60IP	60IP	35	1
183T-75-30IP	30IP	75	1
183T-75-40IP	40IP	75	1
183T-75-45IP	45IP	75	1
183T-75-50IP	50IP	75	1
183T-75-55IP	55IP	75	1
183T-75-60IP	60IP	75	1



7/16"

XZN

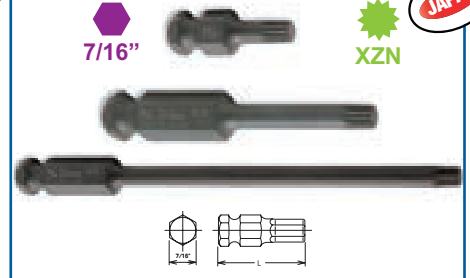
JAPAN



## INSERTO CON MASCHIO XZN

Koken articolo		L mm	
183X-35-M 4	M 4	35	1
183X-35-M 5	M 5	35	1
183X-35-M 6	M 6	35	1
183X-35-M 8	M 8	35	1
183X-35-M10	M10	35	1
183X-35-M12	M12	35	1
183X-35-M14	M14	35	1
183X-75-M 4	M 4	75	1
183X-75-M 5	M 5	75	1
183X-75-M 6	M 6	75	1
183X-75-M 8	M 8	75	1
183X-75-M10	M10	75	1
183X-75-M12	M12	75	1
183X-75-M14	M14	75	1
183X-150-M 5	M 5	150	1
183X-150-M 6	M 6	150	1
183X-150-M 8	M 8	150	1
183X-150-M10	M10	150	1
183X-150-M12	M12	150	1

TORXplus®

	S mm		S mm
8 IP	2.30	30 IP	5.60
9 IP	2.50	40 IP	6.70
10 IP	2.70	45 IP	7.90
15 IP	3.30	50 IP	8.90
20 IP	3.90	55 IP	11.30
25 IP	4.50	60 IP	13.30
27 IP	5.00		

XZN

	S mm		S mm
M 4	3,60	M12	11,50
M 5	4,80	M14	13,30
M 6	6,10	M16	15,70
M 8	7,30	M18	16,90
M10	9,70		

3/8"

TORX®

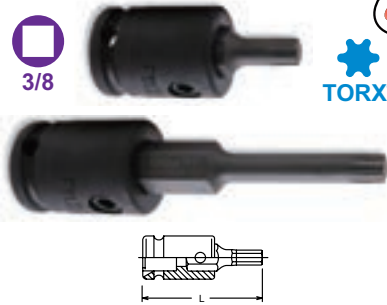

JAPAN



## BUSSOLA MASCHIO ESAGONALE

IN DUE PARTI:

BUSSOLA + INSERTO MASCHIO TORX®

Koken articolo		L mm	
13134T-52-T25 <small>NEW</small>	TX 25	52	1
13134T-52-T30	TX 30	52	1
13134T-52-T40	TX 40	52	1
13134T-52-T45	TX 45	52	1
13134T-52-T50	TX 50	52	1
13134T-52-T55	TX 55	52	1
13134T-52-T60	TX 60	52	1
13134T-92-T30	TX 30	92	1
13134T-92-T40	TX 40	92	1
13134T-92-T45	TX 45	92	1
13134T-92-T50	TX 50	92	1
13134T-92-T55	TX 55	92	1
13134T-92-T60	TX 60	92	1

3/8"

TORXplus®

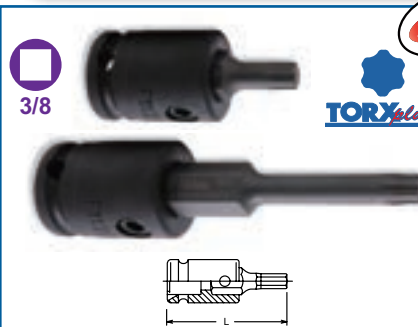

JAPAN



## BUSSOLA MASCHIO ESAGONALE

IN DUE PARTI:

BUSSOLA + INSERTO MASCHIO TORX PLUS®

Koken articolo		L mm	
13134T-52-30IP	30IP	52	1
13134T-52-40IP	40IP	52	1
13134T-52-45IP	45IP	52	1
13134T-52-50IP	50IP	52	1
13134T-52-55IP	55IP	52	1
13134T-52-60IP	60IP	52	1
13134T-92-30IP	30IP	92	1
13134T-92-40IP	40IP	92	1
13134T-92-45IP	45IP	92	1
13134T-92-50IP	50IP	92	1
13134T-92-55IP	55IP	92	1
13134T-92-60IP	60IP	92	1

