

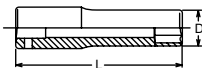

ESAGONO

CHIAVI A BUSSOLA
POWER
BOCCA ESAGONALE
TIPO LUNGO



Koken articolo	mm	D mm	L mm	
23300M-7	7	10.6	55	1
23300M-8	8	12	55	1
23300M-10	10	14.5	55	1
23300M-11	11	16	55	1
23300M-12	12	16.8	55	1
23300M-13	13	18	55	1
23300M-14	14	20	55	1
23300M-15	15	21	55	1
23300M-16	16	22	55	1
23300M-17	17	23.5	55	1
23300M-18	18	24.5	55	1
23300M-19	19	25	55	1

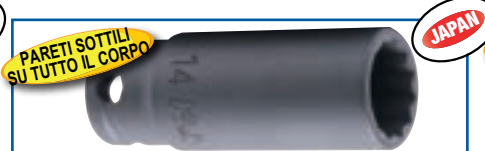

POLIGONALE

CHIAVI A BUSSOLA
POWER
BOCCA POLIGONALE
TIPO LUNGO

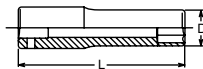

Koken articolo	mm	D mm	L mm	
23305M-8	8	12	55	1
23305M-10	10	14.5	55	1
23305M-12	12	16.8	55	1
23305M-14	14	20	55	1



TORX®

CHIAVI A BUSSOLA
POWER
BOCCA TORX®
TIPO LUNGO

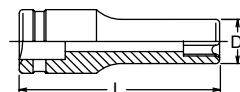

Koken articolo		D mm	L mm	
23325-E 5	E 5	10.2	55	1
23325-E 6	E 6	10.7	55	1
23325-E 7	E 7	11.2	55	1
23325-E 8	E 8	11.7	55	1
23325-E10	E 10	12.2	55	1
23325-E12	E 12	14.2	55	1
23325-E14	E 14	17.2	55	1
23325-E16	E 16	18.2	55	1

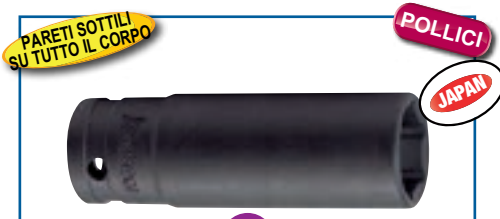

ESAGONO

CHIAVI A BUSSOLA
POWER BOCCA
ESAGONALE
TIPO LUNGO

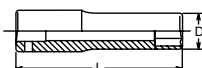

Koken articolo	pollici	D mm	L mm	
23300A-5/16	5/16"	12	55	1
23300A-3/8	3/8"	14	55	1
23300A-7/16	7/16"	16	55	1
23300A-1/2	1/2"	18	55	1
23300A-9/16	9/16"	20	55	1
23300A-11/16	11/16"	23.5	55	1
23300A-3/4	3/4"	25	55	1



SURFACE DRIVE

CHIAVI A BUSSOLA
POWER
BOCCA SURFACE
DRIVE TIPO LUNGO

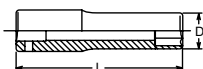

Koken articolo	mm	D mm	L mm	
23310M-8	8	12	55	1
23310M-10	10	14.5	55	1
23310M-12	12	16.8	55	1
23310M-13	13	18	55	1
23310M-14	14	19.5	55	1
23310M-15	15	21	55	1
23310M-17	17	23.5	55	1

BUSSOLE SURFACE DRIVE

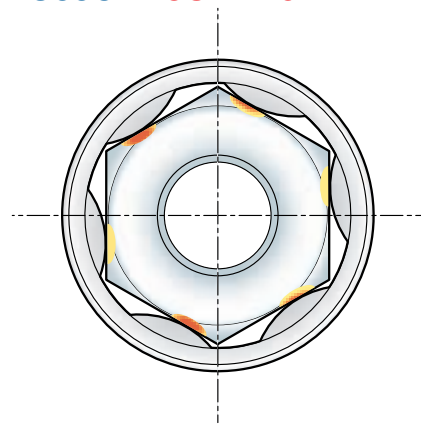

ESAGONO

CHIAVI A BUSSOLA
A MACCHINA BOCCA
ESAGONALE
TIPO EXTRA LUNGO

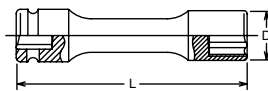

Koken articolo	mm	D mm	L mm	
13145M-100-8	8	13.3	100	1
13145M-100-10	10	15.8	100	1
13145M-100-12	12	18.3	100	1
13145M-100-13	13	19.5	100	1
13145M-100-14	14	20.8	100	1
13145M-100-17	17	24.5	100	1
13145M-150-6	6	10.8	150	1
13145M-150-8	8	13.3	150	1
13145M-150-10	10	15.8	150	1
13145M-150-12	12	18.3	150	1
13145M-150-13	13	19.5	150	1
13145M-150-14	14	20.8	150	1
13145M-150-15	15	22	150	1
13145M-150-17	17	24.5	150	1
13145M-200-6	6	10.8	200	1
13145M-200-8	8	13.3	200	1
13145M-200-10	10	15.8	200	1
13145M-200-12	12	18.3	200	1
13145M-200-13	13	19.5	200	1
13145M-200-14	14	20.8	200	1
13145M-200-15	15	22	200	1
13145M-200-17	17	24.5	200	1
13145M-250-6	6	10.8	250	1
13145M-250-8	8	13.3	250	1
13145M-250-10	10	15.8	250	1
13145M-250-12	12	18.3	250	1
13145M-250-13	13	19.5	250	1
13145M-250-14	14	20.8	250	1
13145M-250-15	15	22	250	1
13145M-250-17	17	24.5	250	1
13145A-150-9/16	9/16"	20	150	1

POLLICI

IMPACT 3/8"