

565/5R moltiplicatore di coppia rapporto 25:1 con dispositivo antiritorno

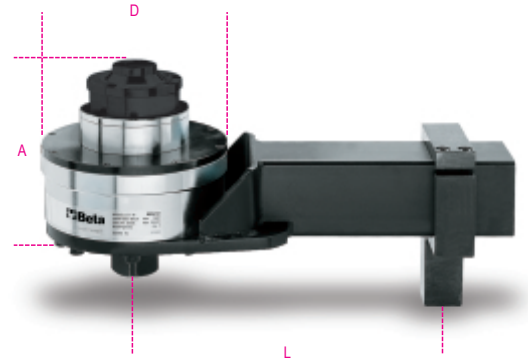

	 005650015	art. 565/5R
--	--	-----------------------